

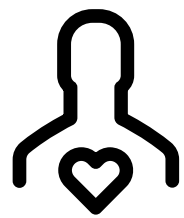

We-semble

Concept

Residents interviewees respond



Assisting residents to set up exercise habit and raising health standard

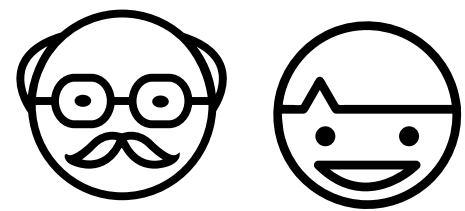

Need of intergenerational facilities



Responding the residents jogging and walking needs

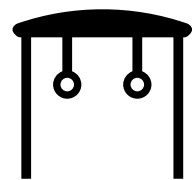

Responding the residents addition gyming facilities needs

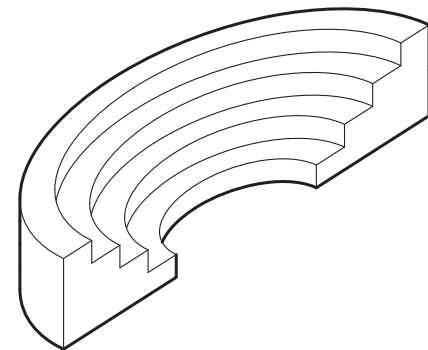

Need of event space, big plaza

Zoning Strategy

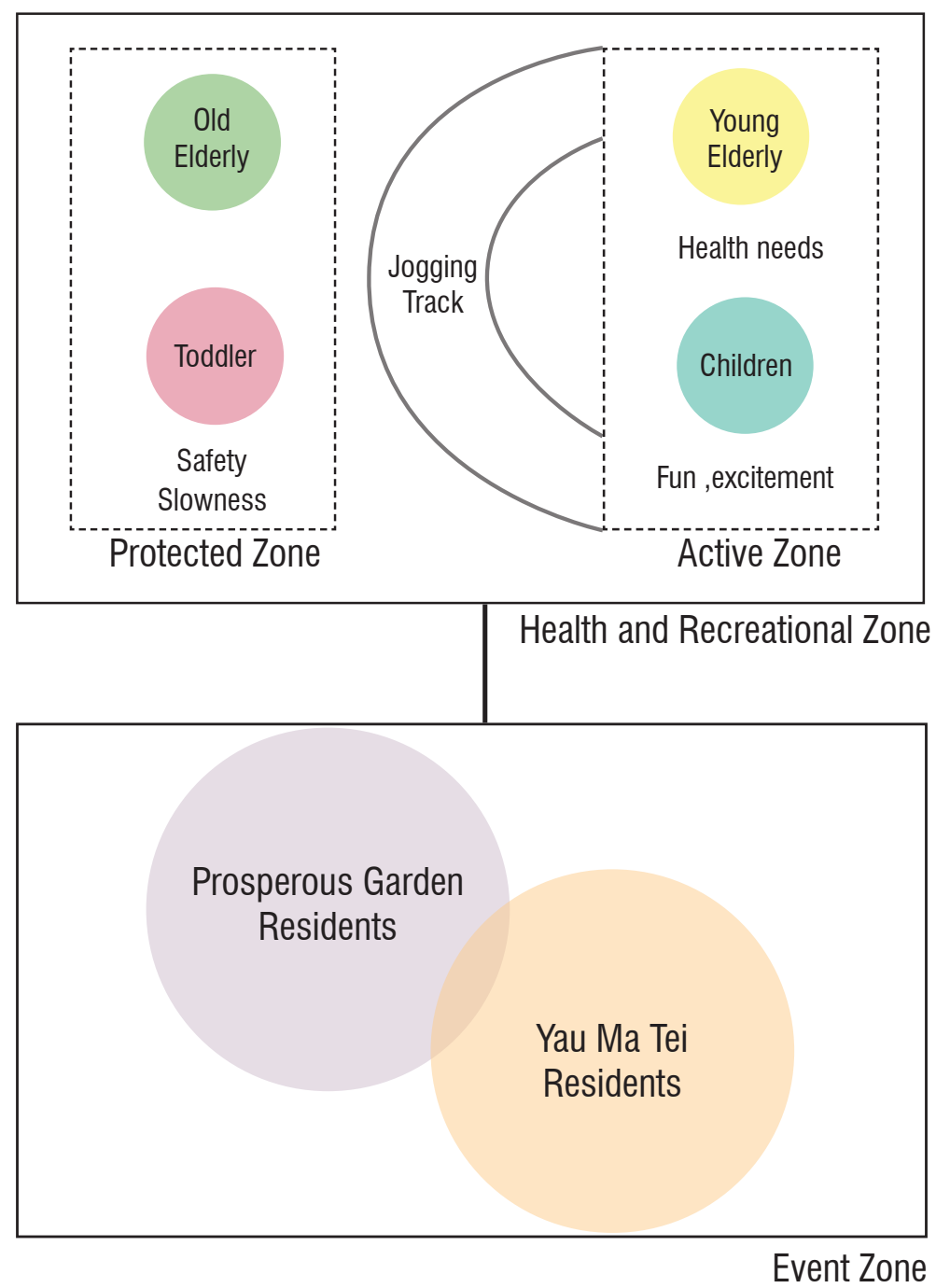

Site Isometric Diagram

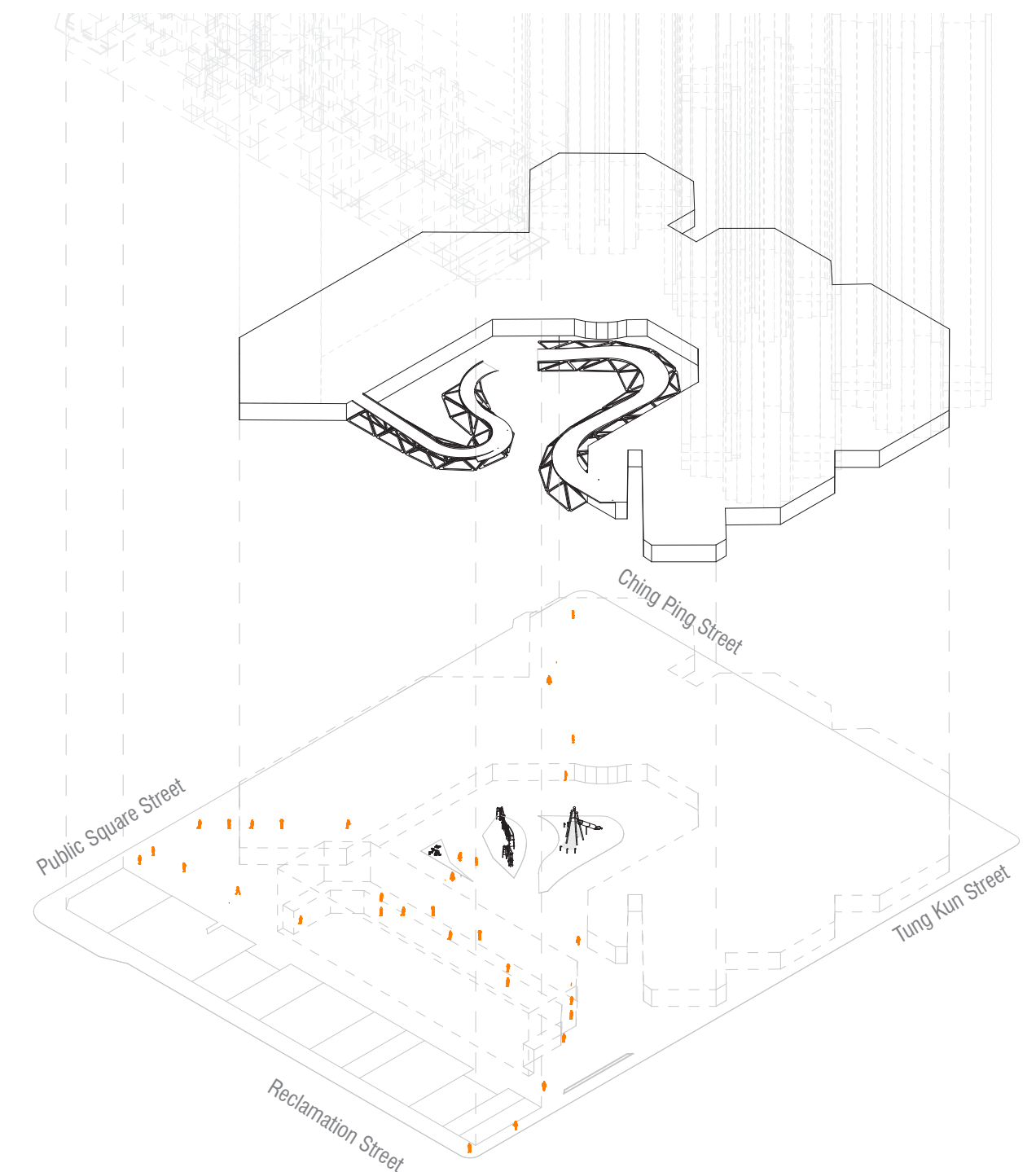

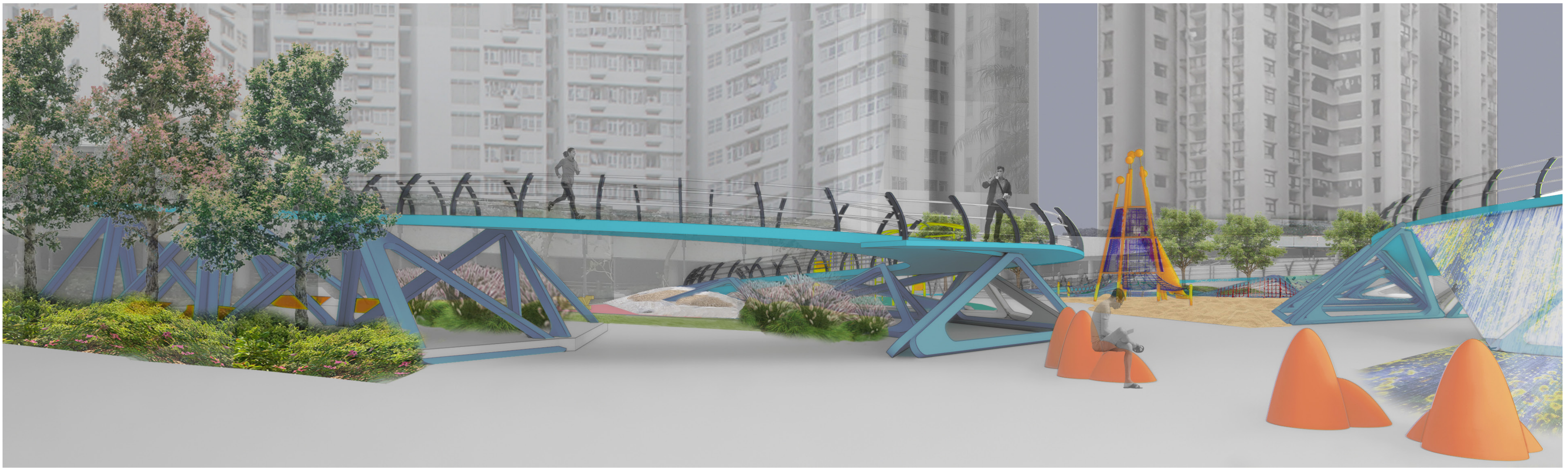

Design

Zoning Plan

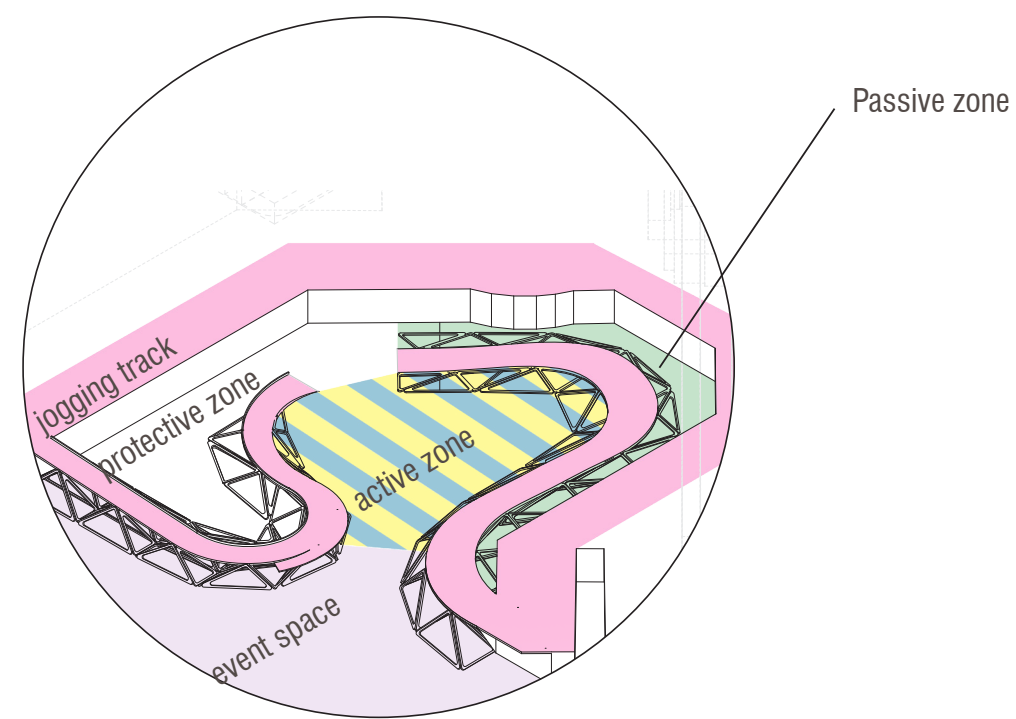

Protective zone : toddler, old elderly
 Active zone: child, teenagers, young elderly

Protected Zone

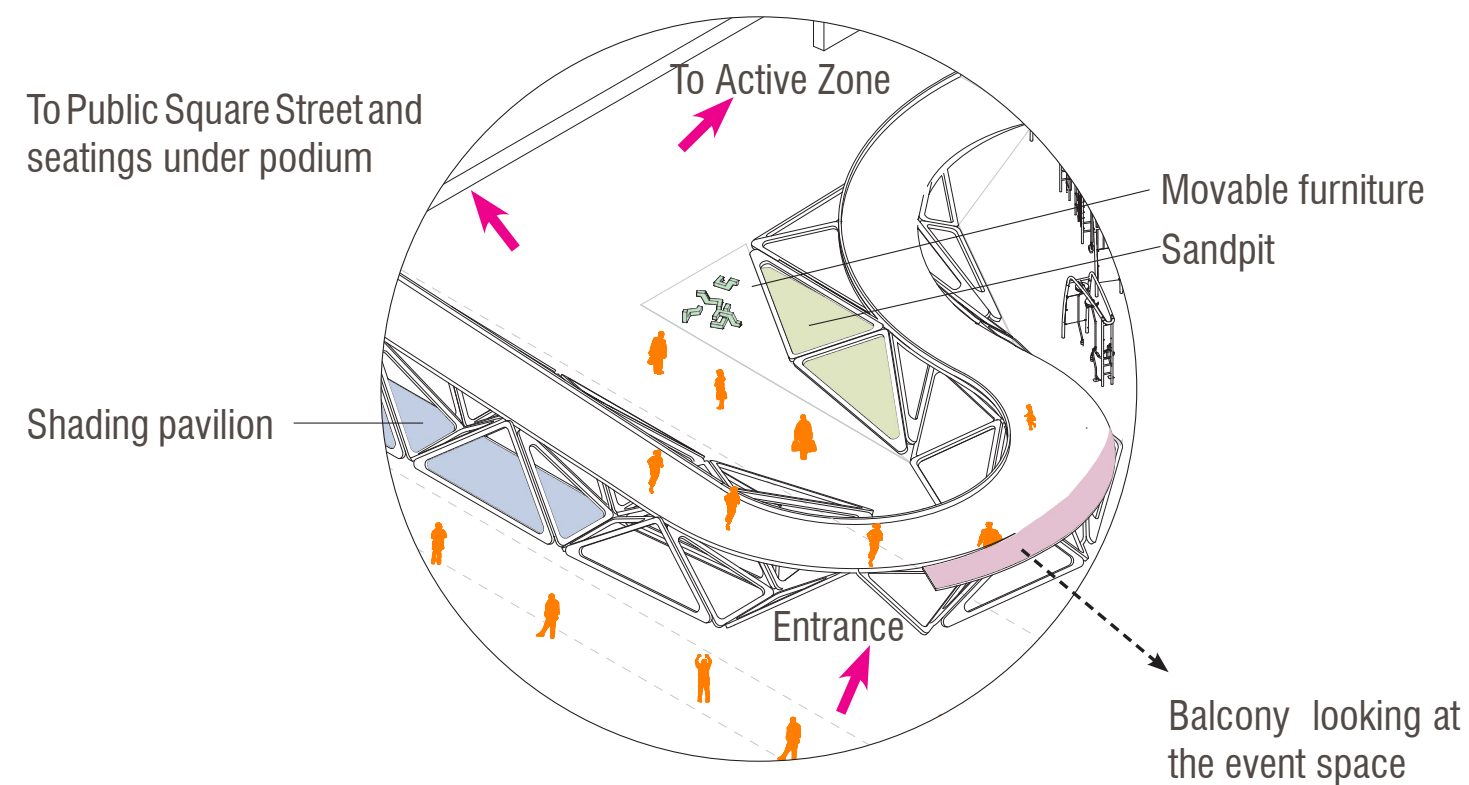

Active Zone

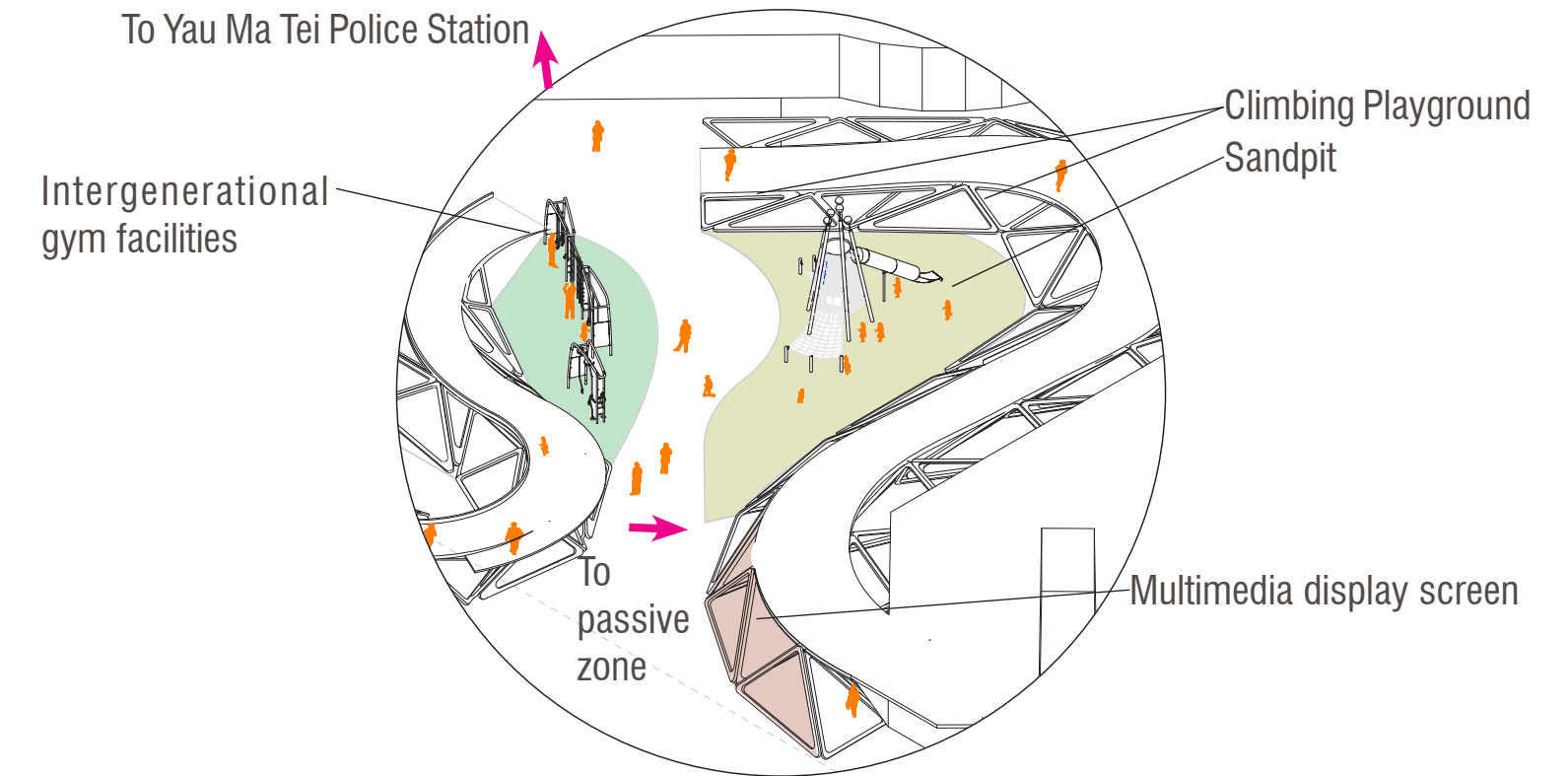

Structural Diagram

